

Commercial in Confidence

CHERVON[®]

**Company
&
Business Overview**

17th August 2023



- Who is Chervon
- Multi Brand Strategy
- EGO
- FLEX
- Question

CHERVON[®]

Who is Chervon?



CHERVON 泉峰[®]
Better Tools. Better World.





OPE

- No. 1 in China, Top 10 in Global Power Tool Industry
- Vertical Integrated Operation
- Go Pro, go Brand, go Global
- Listed in Hong Kong stock exchange (Stock Code: 2285.HK)



AUTO

- World-class manufacturing capacity
- Global top-ranking customer base
- Outstanding process competence
- Listed in Shanghai stock exchange (Stock Code: 603982)

CHERVON R&D CENTER

- Building Area: 36,000 m²
- 7,000m² **GREEN ROOF**, Energy-wise saving the equivalent of **5 litres of petrol per m² each year**



CHERVON INDUSTRY

- Building Area: 170,000 m²
- 22,000 m² **BLUE ROOF**



■ Blue Roof

Chervon Industry, features a 2MW photovoltaic power station, saving the equivalent of **248 tonnes of coal** annually, eliminating Sulphur Dioxide emissions of **16.53 tonnes** and Carbon Dioxide Emissions of **550.43 tonnes** annually.

- 300,000 m²
- 44,000 m² **BLUE ROOF**



CHERVON GREEN POWER



■ Blue Roof

Chervon Green Power, features a 4MW photovoltaic power station, saving the equivalent of **496 tonnes of coal** annually eliminating Sulphur Dioxide emissions of **33.06 tonnes** and Carbon Dioxide Emissions of **1100.86 tonnes** annually.

■ Ground Source

Chervon Green Power, utilizes the latest in ground-source heating, air-conditioning and water-storage technologies. The ground-source heating system alone saves a **massive 1 million KWH of electricity** annually, the equivalent of **378 tonnes of coal**

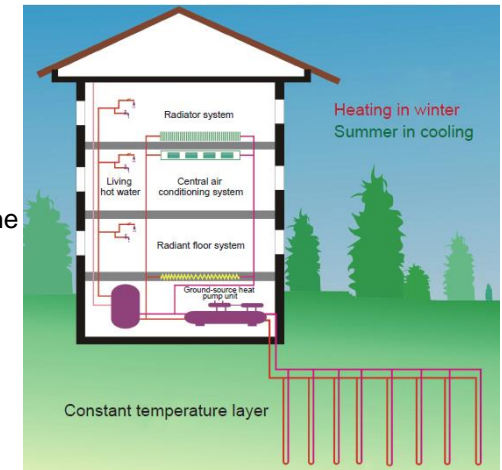

Better Tools. Better World.

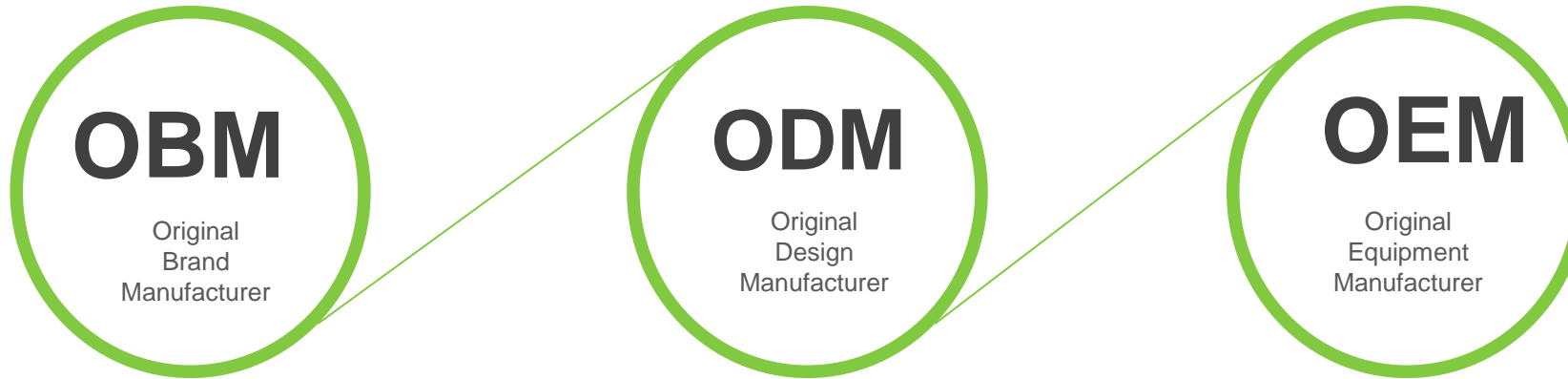

Our Brands

Retailer Brands

Non-CHERVON
Global Brands







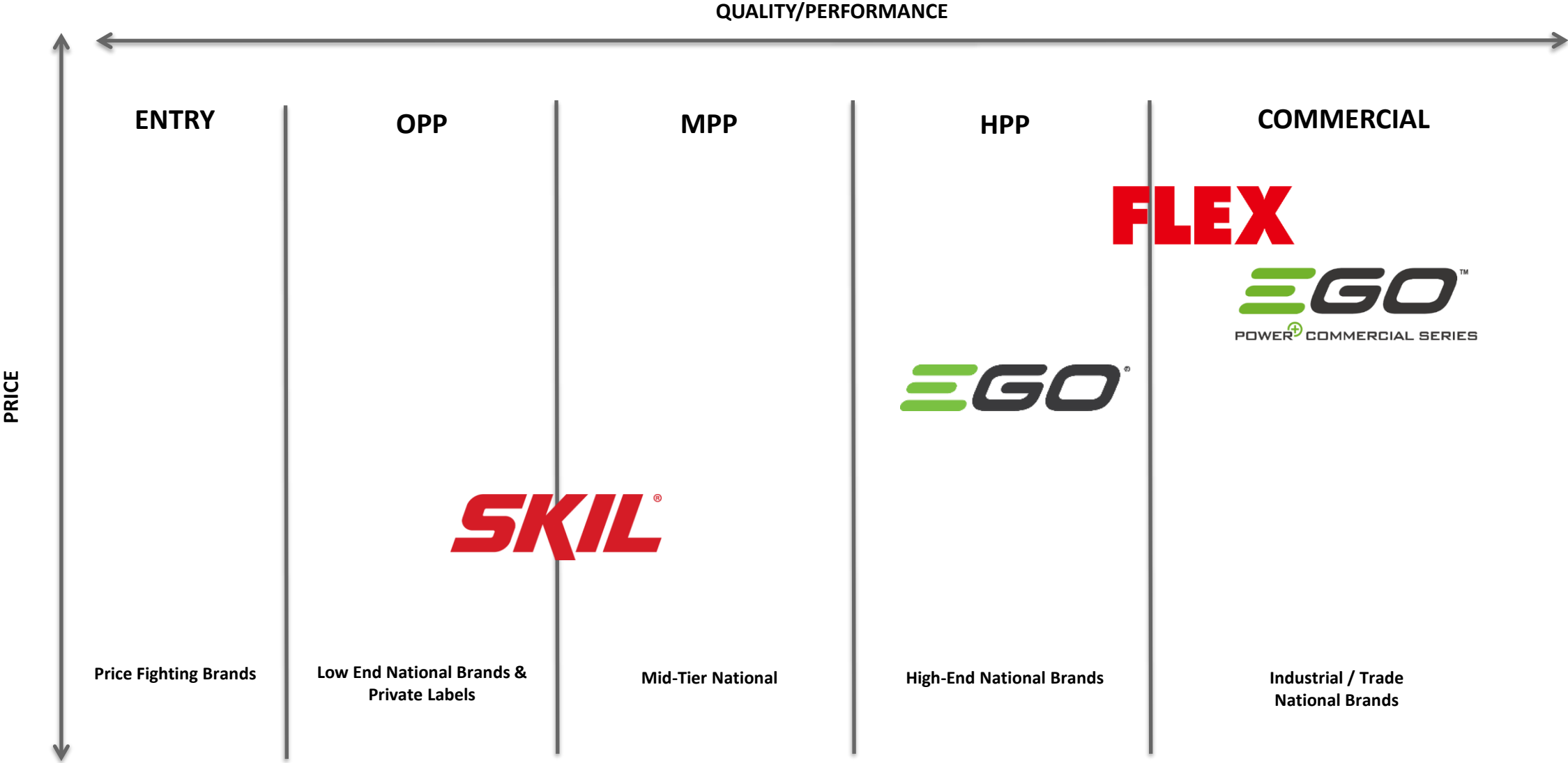

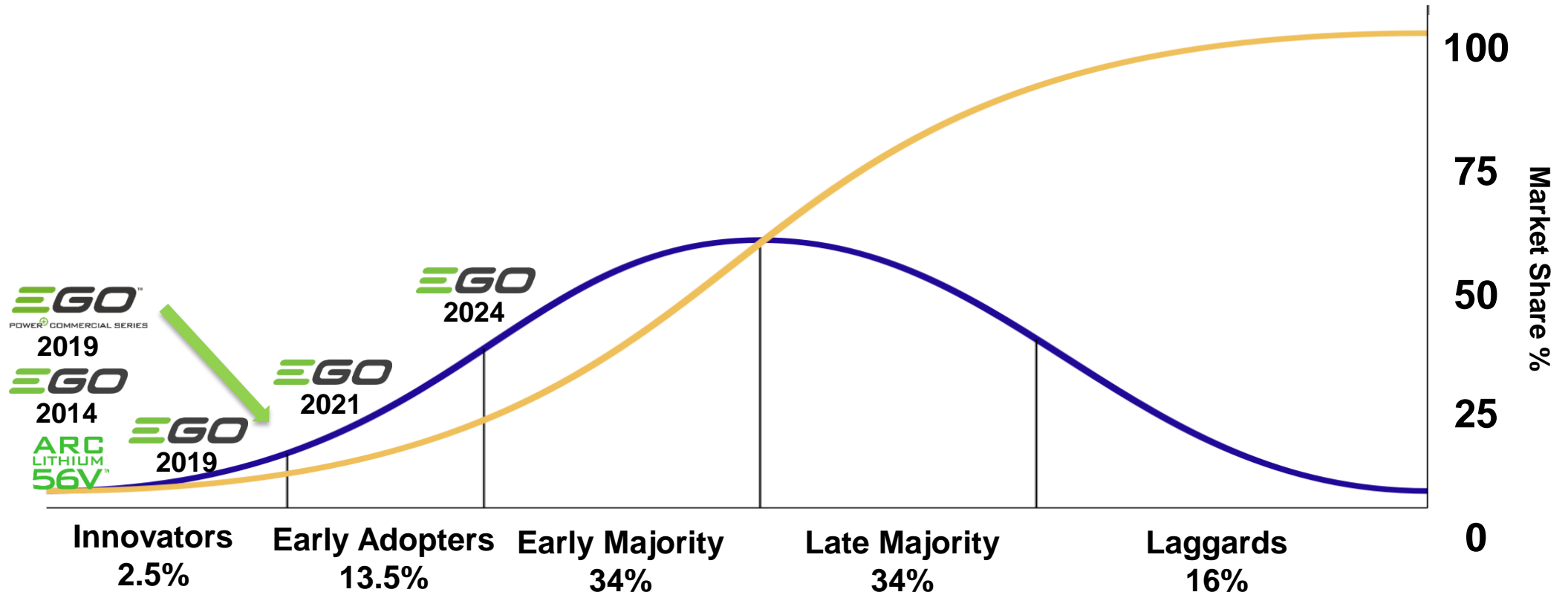

- Green & Environment Focus – crowded space!
- EGO = Environmentally Responsible Luxury
- Leverage ‘Lighthouse Customers’ as ‘EGO Ambassadors’ to influence ‘Early Majority’

WIDEST RANGE

**ONE
BATTERY
POWERS
MULTIPLE
TOOLS**

Our industry-leading 56V ARC Lithium batteries work with all EGO Power+ tools, even our commercial series. With great performance and long run times, simply select your tool, click in and go.

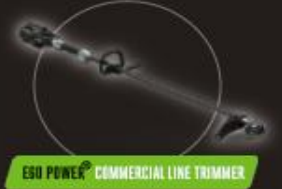

ARC 56V™ LITHIUM



- Most advanced battery
- Longest run times
 - 10.0Ah battery runs up to 80 minutes in a 52cm mower
- Quickest charge times
 - Charge 10.0Ah battery in 70 minutes
- All EGO batteries power all EGO Equipment

Mechanically

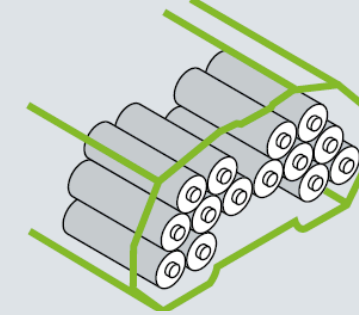

UNIQUE ARC
SHAPE BATTERY

Chemically

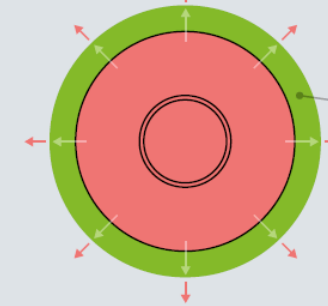

ABSORBS HEAT
ENERGY TO
KEEP CELLS AT
THEIR OPTIMUM
TEMPERATURE
FOR LONGER

Electronically

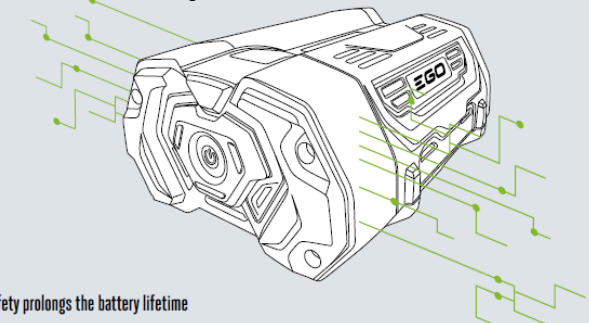

ring safety prolongs the battery lifetime

are only one or two cells being monitored within a battery pack,



Earth Day is an annual celebration that **honors the achievements of the environmental movement and raises awareness of the need to protect Earth's natural resources for future generations.** The first Earth Day was held April 22, 1970

Domestic



Commercial



COMMERCIAL SERIES



National Support

- Australia wide service centres
- 4.5 Days average turn-around time
- Battery & Charger – replacement
- Spare parts inventory held for every product

1300 000



FLEX

this is proformance



FLEX was founded on December 7, 1922, in Stuttgart-Bad Cannstatt, Germany as a manufacturer of hand-held grinding machines.

1922 to 2022 - 100 years of FLEX - Innovation and Tradition



**Hermann
Ackermann**

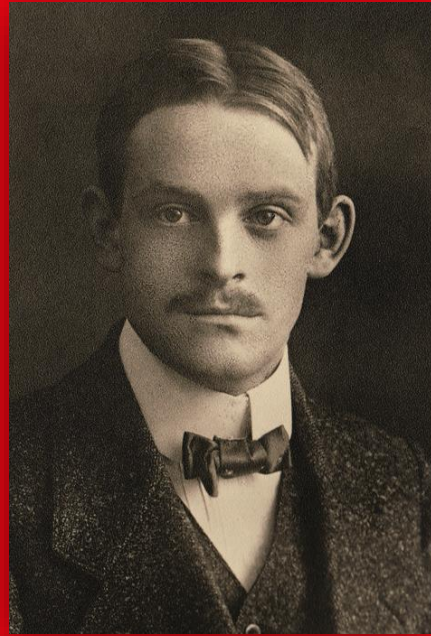

**Hermann
Schmitt**



The first mass-produced hand grinding machine MS 6 was driven by a flexible shaft. This FLEXible shaft gave the Brand its name: FLEX

2022
100
YEARS
FLEX



Owners' history



Foundation
of the company
Ackermann +
Schmitt



Pentair concern
(tools division
Porter-Cable)



Porter-Cable
(incl. FLEX)
sold to
Black & Decker



Investor
GSO Capital
Partners

AXA-Group

Eleve Vier wealth
management
& bank consortium

Flex becomes
part of the
Chervon Group



Owners' history



Foundation
of the company
Ackermann +
Schmitt



Pentair concern
(tools division
Porter-Cable)



Porter-Cable
(incl. FLEX)
sold to
Black & Decker



Investor
GSO Capital
Partners

AXA-Group

Eleve Vier wealth
management
& bank consortium

Flex becomes
part of the
Chervon Group



Power Tool Market Overview

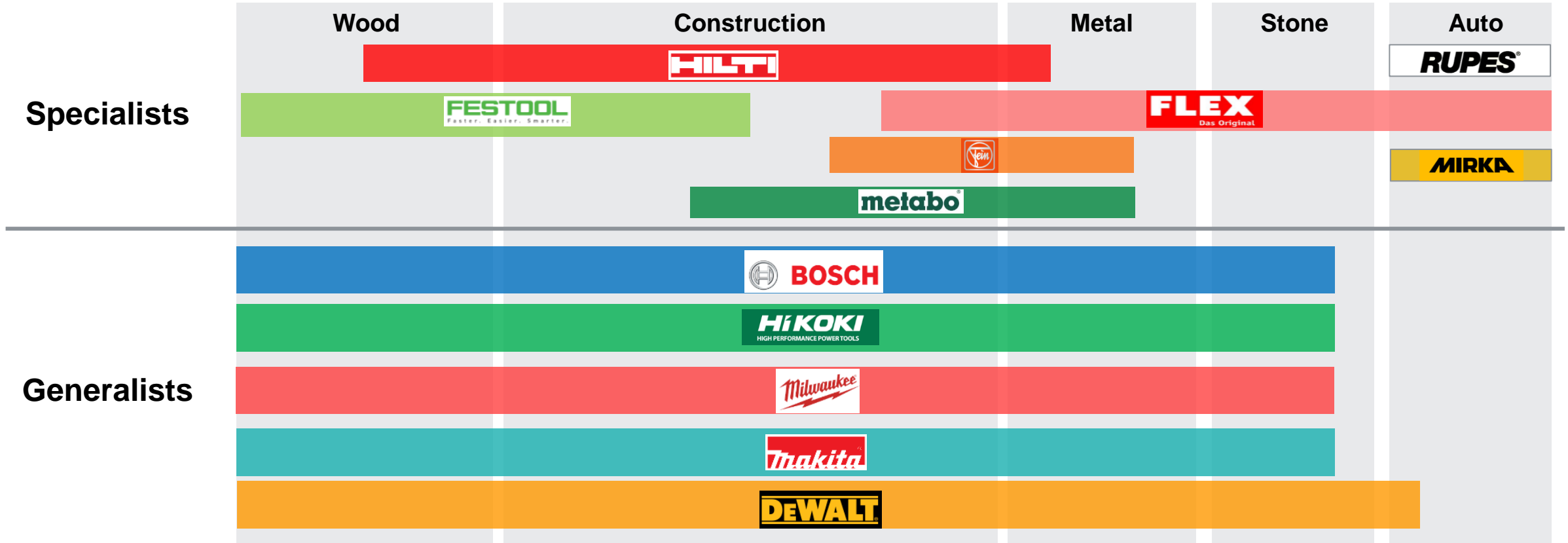

Construction / Renovation



FLEX is a specialist for the painter and drywaller, whatever the task in floor, wall and ceiling finishing

Metal Working



Specially tailored to the diverse requirements of metal finishers, such as stainless steel, light metal construction and container building

Automotive



Flex is a market leader in painted surface finishing, the program provides the optimum solution for the most varied of requirements.

Natural Stonework



For 90 years FLEX has been a competent and innovative partner for natural stone in various requirements

Clear focus on four market segments

Refurbishment & Renovation:

- Drywall
- Painter
- Tile layers

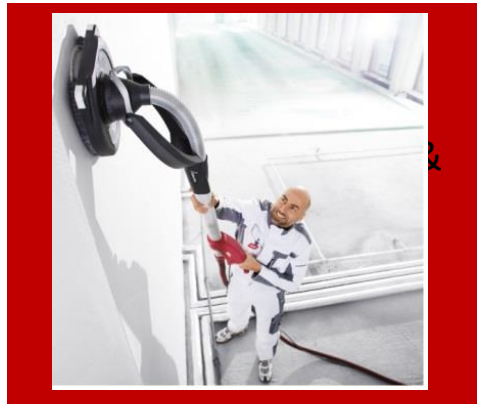

Metal Working:

- Light steel construction
- Stainless steel
- Container building



Stone Working:

- Stone mason
- Slab laying
- Kitchen / Benchtop fabricators



Automotive:

- Detailing
- Smart repair
- Car body shops



Point of Difference is KEY



Drive

Properties

Rotary

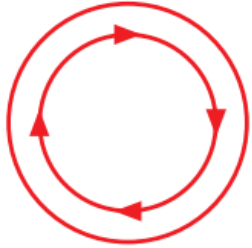

- ⚠ Highest removal rate
- ⚠ Rotary polishers require experience
- ⚠ Quickest way to remove scratches
- ⚠ Hologram formation possible

Abrasiveness



Speed ¹



Holograms ²



Hologram removal



Random orbital, with positive-action drive



- ⚠ Good removal performance
- ⚠ No hologram formation
- ⚠ Suitable for removing scratches and for finishing
- ⚠ Wide range of applications

Abrasiveness



Speed ¹



Holograms ²



Hologram removal



Random orbital, free-running



- ⚠ Suitable for all types of user
- ⚠ Easy to handle
- ⚠ No hologram formation
- ⚠ Poor removal performance
- ⚠ Ideal for finishing

Abrasiveness



Speed ¹



Holograms ²



Hologram removal



PE = Rotary



XCE = Forced Action / Positive Action Drive



XFE = Random Orbital Free Running





30

DAY
MONEY BACK
GUARANTEE

- 30 Day Money Back Guarantee
- Promoted in store through POS
- Processed at store level
- Credit applied to store once approved

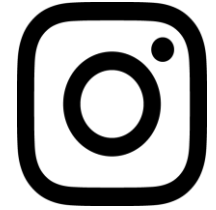

Made for experts

Try FLEX for 30 days. If it's too much tool for you, we'll give you your money back. Terms & Conditions apply.

FLEX
this is performance



**3 YEAR
WARRANTY***

TOOLS • BATTERIES • CHARGERS

*Standard 2 year warranty with an additional 1 year warranty subject to online registration. Full warranty details online.

- **Repair Warranty**
- **Registration = Extra 1 Year**
- **Store level repair option**

Phone Number: Australia 1300 000 346

Email Address: support@flex-tools.com.au

Website: www.flex-tools.com.au



Thank You

INTEGRITY • DILIGENCE • ENTHUSIASM • ASPIRATION

Better Tools. Better World.